

1 SOCIAL SERVICES SPACE PLAN  
SCALE: 1/4" = 1'-0"

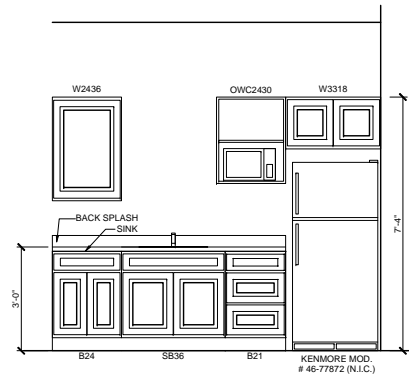

2 INTERIOR ELEVATION  
SCALE: 1/2" = 1'-0"

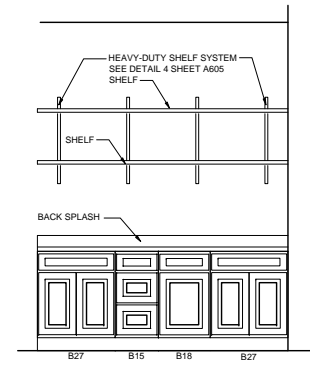

3 INTERIOR ELEVATION  
SCALE: 1/2" = 1'-0"

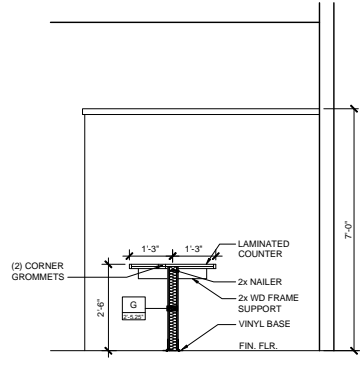

4 INTERIOR ELEVATION  
SCALE: 1/2" = 1'-0"

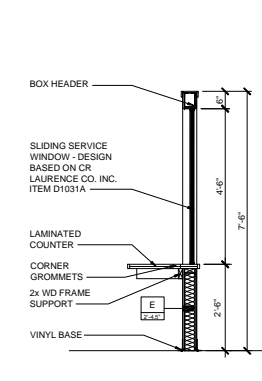

5 INTERIOR ELEVATION  
SCALE: 1/2" = 1'-0"

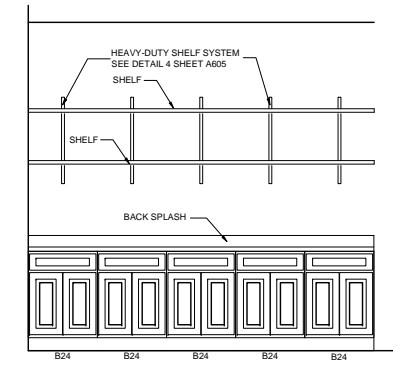

6 INTERIOR ELEVATION  
SCALE: 1/2" = 1'-0"

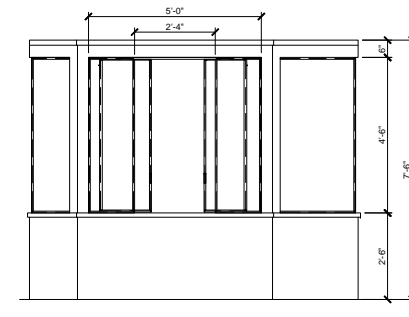

7 INTERIOR ELEVATION  
SCALE: 1/2" = 1'-0"

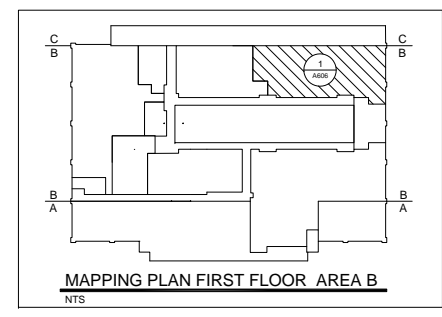

MAPPING PLAN FIRST FLOOR AREA B  
NTS

REVISIONS		NO.	DATE	REMARKS

DESIGNER: JEFFREY M. HARRIS  
ARCHITECT: JEFFREY M. HARRIS  
PROJECT: TRI - COUNTY MULTI-PURPOSE CENTER  
BUILDING ENVELOPE AND INTERIOR RENOVATION  
SALISBURY, MARYLAND  
DATE: 11.1.2010  
SCALE: AS NOTED  
STAGE: ISSUED FOR BID  
DWG. FILE: 06-036-A006

**JOINT**  
ARCHITECTURE  
ENGINEERING  
INCORPORATED  
310 HAMMOND ST. • SUITE 100 • SALISBURY, MARYLAND  
(410) 744-7229 • FAX (410) 744-0001

**TRI - COUNTY MULTI-PURPOSE CENTER  
BUILDING ENVELOPE AND  
INTERIOR RENOVATION  
SALISBURY, MARYLAND**  
SOCIAL SERVICES SPACE PLAN

PRINT DATE: 11.1.2010  
LITTT PROJ. NO.: 09025  
DESIGNER: JMH  
DRAWN BY: JMH  
SCALE: AS NOTED  
STAGE: ISSUED FOR BID  
DWG. FILE: 06-036-A006

**A  
606**